

Mi Automatic Foaming Soap Dispenser

User Manual



Read this manual carefully before use, and retain it for future reference.

This appliance can be used by children aged from 8 years and above and persons with reduced physical, sensory or mental capabilities or lack of experience and knowledge if they have been given supervision or instruction concerning use of the appliance in a safe way and understand the hazards involved. Children shall not play with the appliance. Cleaning and user maintenance shall not be made by children without supervision. (For European countries or regions)

This appliance is not intended for use by persons (including children) with reduced physical, sensory or mental capabilities, or lack of experience and knowledge, unless they have been given supervision or instruction concerning use of the appliance by a person responsible for their safety. Children should be supervised to ensure that they do not play with the appliance. (For non European countries or regions)

Non-rechargeable batteries are not to be recharged.

Different types of batteries or new and used batteries are not to be mixed.

Batteries are to be inserted with the correct polarity.

Exhausted batteries are to be removed from the appliance and safely disposed of.

If the appliance is to be stored unused for a long period, the batteries should be removed.

The supply terminals are not to be short-circuited.

Product Overview

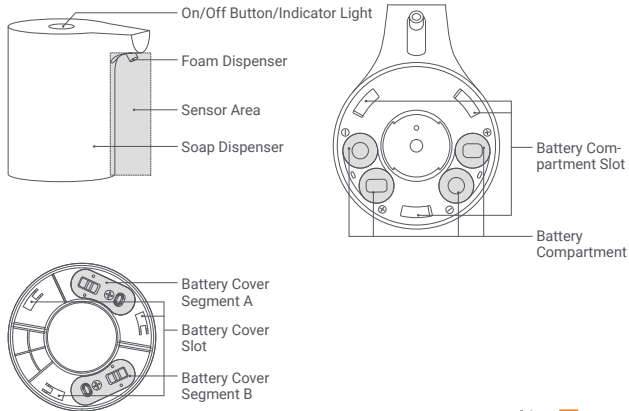

Soap Dispenser Features



Contactless & Hygienic



Creamy Foam



IPX4 Waterproof



Elegant & Durable



We Shanghai Xiaowei Cosmetics Co., Ltd., hereby, declares that this equipment is in compliance with the applicable Directives and European Norms, and amendments. The full text of the EU declaration of conformity is available at the following internet address:

<http://www.mi.com/global/service/support/declaration.html>



All products bearing this symbol are waste electrical and electronic equipment (WEEE as in directive 2012/19/EU) which should not be mixed with unsorted household waste. Instead, you should protect human health and the environment by handing over your waste equipment to a designated collection point for the recycling of waste electrical and electronic equipment, appointed by the government or local authorities. Correct disposal and recycling will help prevent potential negative consequences to the environment and human health. Please contact the installer or local authorities for more information about the location as well as terms and conditions of such collection points.

Installation

①

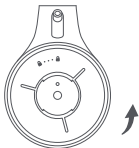

Loosen the battery cover counterclockwise.

②

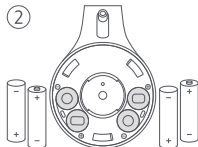

Correctly align the batteries with the positive and negative symbols (+/-) when inserting them.

③

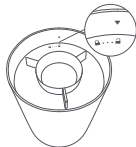

Align the unlocked symbol on the battery cover with the triangular symbol on the side of the dispenser.

④

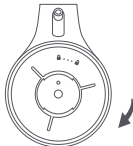

Turn the battery cover clockwise until the lock symbol aligns with the triangular symbol.

⑤



Unscrew the hand soap cover counterclockwise, and remove the silicon plug.

⑥





Align the hand soap with the bottom of the dispenser and gently turn it counterclockwise until it is secure.

Instructions

①  Tap the On/Off button to turn on the Mi Automatic Soap Dispenser.

②  It is recommended to first rinse your hands with water to moisten them.

③  Move your hands into the sensor area to dispense foam.

④  It is recommended to thoroughly rub your hands.

⑤  Dry your hands after washing them with water.

Note: When the soap dispenser is not being used, it will automatically go into standby mode. It is not necessary to manually turn it off.

Status	Indicator Light Status
On	White remains on for 1.5 seconds
Off*	Orange blinks and turns off shortly
Low battery	Orange remains on for 3 seconds after the sensor is triggered
Error (the sensor area is blocked by foam)	Orange blinks quickly

*When the dispenser is on, tap the On/Off button to turn it off.

Maintenance

- For cleaning, it is recommended to gently wipe the surface of the device with a wet towel when it is turned off.
- If the product will not be used for a long time, please take out the batteries to avoid them from getting damp or starting to leak.

Precautions

- Do not immerse the product in water nor rinse it directly with water to avoid short circuits.
- Do not tilt the bottle when installing or replacing the hand soap. It is normal if a small amount of liquid overflows, it can still be used normally after wiping it clean.
- Do not use non-foaming hand soap in order to avoid the device from malfunctioning.
- Store this product in a cool place away from direct sunlight or heat sources.
- Only use the dispenser when the batteries and the compartment are thoroughly dry. In case the dispenser encounters any water spray, inversion, or tilt, immediately check the batteries and the compartment.
- Please recycle the used batteries.



Troubleshooting

Fault	Possible Causes	Solutions
Cannot turn on/off	Incorrectly installed the battery's positive and negative.	Reinstall the batteries.
Indicator does not light up	The product is not turned on yet.	Turn it on.
	Incorrectly installed the battery's positive and negative.	Reinstall the batteries.
Cannot produce foam	The hand soap has been used up.	Replace the hand soap.
	The batteries are depleted.	Replace the batteries with new ones.
Quickly blinking orange	The sensor area is blocked by foam.	Turn the product off, clean the sensor area and turn it on again.

Specifications

Model	MJXSJ03XW
Main Material	ABS
Rated Voltage	6 V 
Battery Type	AA LR6*
Operating Temperature	5°C to 40°C
Operating Humidity	0% - 85% RH

* AA LR6 × 4 are not included and sold separately.

WARRANTY NOTICE

THIS WARRANTY GIVES YOU SPECIFIC RIGHTS, AND YOU MAY HAVE OTHER RIGHTS CONVEYED BY LAWS OF YOUR COUNTRY, PROVINCE OR STATE. INDEED, IN SOME COUNTRIES, PROVINCES OR STATES, CONSUMER LAW MAY IMPOSE A MINIMUM WARRANTY PERIOD. OTHER THAN AS PERMITTED BY LAW, XIAOMI DOES NOT EXCLUDE, LIMIT OR SUSPEND OTHER RIGHTS YOU MAY HAVE. FOR A FULL UNDERSTANDING OF YOUR RIGHTS WE INVITE YOU TO CONSULT THE LAWS OF YOUR COUNTRY, PROVINCE OR STATE.

1. LIMITED PRODUCT WARRANTY

XIAOMI warrants that the Products are free from defects in materials and workmanship under normal use and use in accordance with the respective Product user manual, during the Warranty Period.

The duration and conditions related to the legal warranties are provided by respective local laws. For more information about the consumer warranty benefits, please refer to Xiaomi's official website <http://www.mi.com/en/service/warranty/>.

Xiaomi warrants to the original purchaser that its Xiaomi Product will be free from defects in materials and workmanship under normal use in the period mentioned above.

Xiaomi does not guarantee that the operation of the Product will be uninterrupted or error free.

Xiaomi is not liable for damages arising from non-compliance with the instructions related to the use of the Product.

2. REMEDIES

If a hardware defect is found and a valid claim is received by Xiaomi within the Warranty Period, Xiaomi will either (1) repair the product at no charge, (2) replace the product, or (3) refund the Product, excluding potential shipping costs.

3. HOW TO OBTAIN WARRANTY SERVICE

To obtain warranty service, you must deliver the Product, in its original packaging or similar packaging providing an equal degree of Product protection, to the address specified by Xiaomi. Except to the extent prohibited by applicable law, Xiaomi may require you to present proofs or proof of purchase and / or comply with registration requirements before receiving warranty service.

4. EXCLUSIONS AND LIMITATIONS

Unless otherwise stipulated by Xiaomi, this Limited Warranty applies only to the Product manufactured by or for Xiaomi and identifiable by the trademarks, trade name or "Xiaomi" or "Mi" logo.

The Limited Warranty does not apply to any (a) Damage due to acts of nature or God, for example, lightning strikes, tornadoes, flood, fire, earthquake or other external causes; (b) Negligence; (c) Commercial use; (d) Alterations or modifications to any part of the Product; (e) Damage caused by use with non-Xiaomi products; (f) Damage caused by accident, abuse or misuse; (g) Damage caused by operating the Product outside the permitted or intended uses described by Xiaomi or with improper voltage or power supply; or (h) Damage caused by service (including upgrades and expansions) performed by anyone who is not a representative of Xiaomi.

It is your responsibility to backup any data, software, or other materials you may have stored or preserved on the product. It is likely that the data, software or other materials in the equipment will be lost or reformatted during the service process, Xiaomi is not responsible for such damage or loss.

No Xiaomi reseller, agent, or employee is authorized to make any modification, extension, or addition to this Limited Warranty. If any term is held to be illegal or unenforceable, the legality or enforceability of the remaining terms shall not be affected or impaired.

Except as prohibited by laws or otherwise promised by Xiaomi, the after-sales services shall be limited to the country or region of the original purchase.

Products which were not duly imported and/or were not duly manufactured by Xiaomi and/or were not duly acquired from Xiaomi or a Xiaomi's official seller are not covered by the present warranties. As per applicable law you may benefit from warranties from the non-official retailer who sold the product. Therefore, Xiaomi invites you to contact the retailer from whom you purchased the product.

5. IMPLIED WARRANTIES

Except to the extent prohibited by applicable law, all implied warranties (including warranties of merchantability and fitness for a particular purpose) will have a limited duration up to a maximum duration of this limited warranty. Some jurisdictions do not allow limitations on the duration of an implied warranty, so the above limitation will not be applied in these cases.

6. DAMAGE LIMITATION

Except to the extent prohibited by applicable law, Xiaomi shall not be liable for any damages

caused by accidents, indirect, special or consequential damages, including but not limited to loss of profits, revenue or data, damages resulting from any breach of express or implied warranty or condition, or under any other legal theory, even if Xiaomi has been informed of the possibility of such damages. Some jurisdictions do not allow the exclusion or limitation of special, indirect, or consequential damages, so the above limitation or exclusion may not apply to you.

7. XIAOMI CONTACTS

For customers, please visit the website: <https://www.mi.com/en/service/warranty/>

The contact person for the after-sale service may be any person in Xiaomi's authorized service network, Xiaomi's authorized distributors or the final vendor who sold the products to you. If in doubt please contact the relevant person as Xiaomi may identify.

Importer:
Beryko s.r.o.
Na Roudné 1162/76, 301 00 Plzeň
www.beryko.cz